

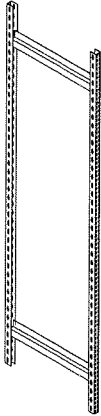

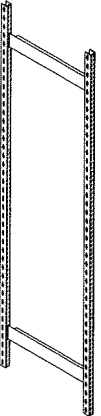

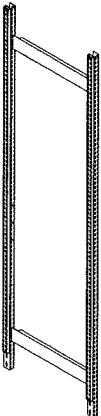

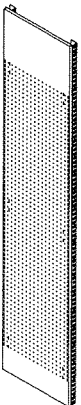
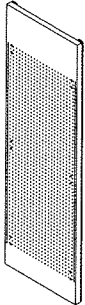

LONGSPAN

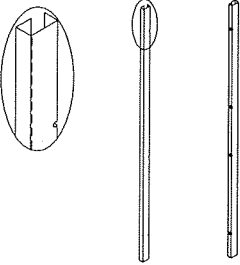
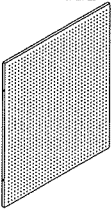
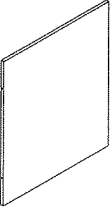
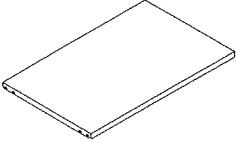
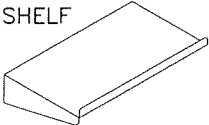
LONGSPAN				
	HEIGHTS	DEPTHS		
<p>WELDED FRAMES</p> 	<p>1.8m – 3.6m</p> <p>PART NUMBER SERIES</p>	<p>0.300mm – 1.2m</p> <p>311000 – 312300</p> <p>DWG # 31/003A</p>		
<p>W.W. WELDED FRAMES</p> 	<p>1.5m – 3.2m</p> <p>PART NUMBER SERIES</p>	<p>0.300mm – 0.900mm</p> <p>313000 – 314400</p> <p>V31400 – V31405</p> <p>DWG # 31/002A</p>		
<p>W.W. WING FRAME LH/RH</p> 	<p>2.1m</p> <p>PART NUMBER SERIES</p>	<p>0.600mm</p> <p>314500 – 314580</p> <p>DWG # 31/004A</p>		
<p>W.W. PERF END FRAME LH/RH</p> 	<p>1.8m – 2.1m</p> <p>PART NUMBER SERIES</p>	<p>450mm,600mm</p> <p>314600 – 314800</p> <p>DWG # REFER PART#</p>		

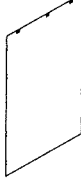

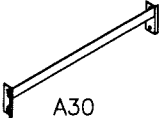
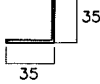
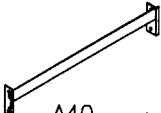
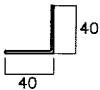
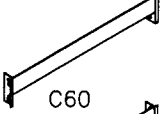
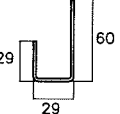
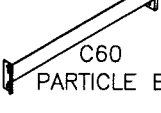
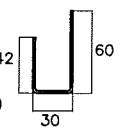
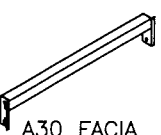
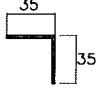
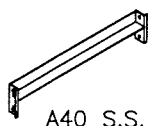
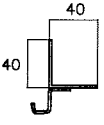
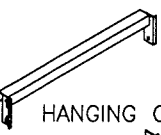
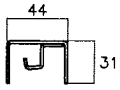
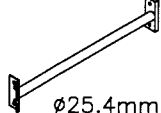
LONGSPAN

	HEIGHTS	DEPTHS	
LSPN PERF END UNIT 	1.9m , 2.1m PART NUMBER SERIES	600mm 315290 - 315390 DWG # REFER PART#	
LSPN PLAIN END UNIT 	1.8m PART NUMBER	750mm 315200 DWG # REFER PART#	
LSPN END POST 	1.9m , 2.1m , 2.8m PART NUMBER SERIES	V31100 - V31192 DWG # REFER PART#	
LSPN PERF FILLER PANELS 	950mm 1050mm PART NUMBER SERIES	900mm , 1000mm V33150 - V33212 DWG # REFER PART#	
LSPN PLAIN FILLER PANELS 	950mm 1050mm PART NUMBER SERIES	900mm , 1000mm V33300 - V33442 DWG # REFER PART#	
LONGSPAN SHELF PLAIN FRONT & REAR 	600mm , 900mm PART NUMBER SERIES	300mm , 350mm , 400mm , 450mm , 500mm , 600mm , 750mm , 900mm 320000 - 320580 (900mm) 321100 - 321650 (600mm)	
LONGSPAN SHELF SPECIALS 	600mm , 900mm PART NUMBER SERIES	300mm , 350mm , 400mm , 450mm , 500mm , 600mm , 750mm , 900mm 322000 - 322500 V32050 - V32402	

LONGSPAN		
	HEIGHTS	DEPTHS
LSPN END CLADDING PANEL 	1.8m , 2.1m PART NUMBER SERIES	450mm , 600mm 331100 - 331300 DWG # 33/001A
W.W. REAR CLADDING PANEL 	1.8m , 2.1m , 2.7m PART NUMBER SERIES	331070 - 331072 (888mm MODULE) DWG # 33/012A 331304 (1200mm MODULE) DWG # 33/008A
W.W END CLADDING PANEL 	2.1m PART NUMBER SERIES	450mm , 600mm 331400 - 331470 S/F DWG # REFER PART# D/F DWG # REFER PART#
BEAMS		LENGTHS (FRONT & BACK)
 A30   A40   C60   C60 PARTICLE BOARD   A30 FACIA   A40 S.S. HANGING   HANGING CHANNEL   ø25.4mm RETAINER  RETAINER (PUNCHED)	PART NUMBER SERIES	600mm , 700mm , 888mm , 900mm , 960mm , 1200mm , 1500mm , 1800mm 340000 - 341690 V34050 - V34320 DWG # REFER PART# <u>NOTE</u> WHEN ORDERING PARTICLE BOARD SHELVES FOR W.W. WELDED FRAMES ORDER PARTICLE BOARD 15mm LESS THAN ORDERED FRAME SIZE WHEN ORDERING PARTICLE BOARD SHELVES FOR WELDED FRAMES ORDER PARTICLE BOARD 10mm LESS THAN ORDERED FRAME SIZE V34400 - V34460

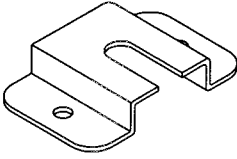
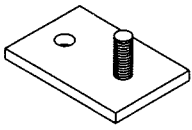
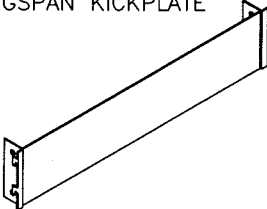
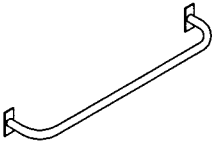
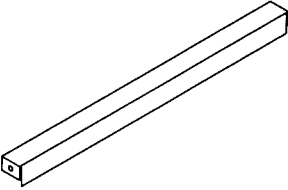
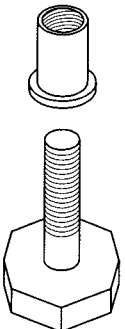
LONGSPAN

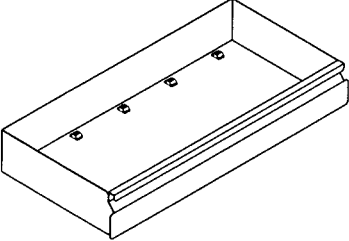
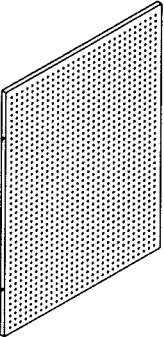
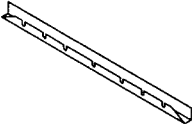
ACCESSORIES	DIMENSION	PART NUMBER	DRAWING NUMBER
<p>SCREW FOOT SLIPPER</p> 		<p>360100 , 2 , 5</p>	<p>36/003A</p>
<p>HEAVY DUTY FOOT PLATE</p> 		<p>360110 , 2 , 5</p>	<p>36/002A</p>
<p>LONGSPAN KICKPLATE</p> 	<p>900mm , 1200mm</p>	<p>386050 – 386170 V36300 – V36360</p> <p>DWG # REFER PART#</p>	<p>DWG # REFER PART#</p>
<p>LONGSPAN MOBILE HANDLE</p> 	<p>900mm</p>	<p>386200 , 2</p> <p>DWG # REFER PART#</p>	<p>38/005A</p>
<p>LSPN DECKING SUPPORT</p> 	<p>600mm , 900mm</p>	<p>386271 – 92</p>	<p>38/002A</p>
<p>ADJUSTABLE SCREW FOOT SET</p> 	<p>40mm HIGH</p>	<p>387160</p>	

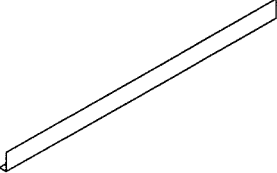
LONGSPAN			
ACCESSORIES	DIMENSION	PART NUMBER	DRAWING NUMBER
HD CORNER POST PROTECTOR 	500mm	386320 , 1 , 2	08/003A
LSPN FLOOR DRAWER SET 	900mm x 450mm 1200mm x 450mm	386380 386400	DWG # REFER PART#
PERF LSPN FRAME 	HEIGHTS 400mm , 600mm , 900mm WIDTHS 600mm , 900mm , 1200mm 1800mm , 2000mm	PART NUMBER SERIES 386450 - 386720	DWG # REFER PART#
W.W. PEG BOARD FRAME RAIL 	250mm , 450mm , 500mm , 600mm	PART NUMBER SERIES 386730 - 386800	DWG # REFER PART#
LSPN STRUT SPLICE 	350mm	PART NUMBER SERIES 386830 - 386840	38/018A
ACRYLIC BEAM FRONT 	1200mm x 75mm	387080	

LONGSPAN

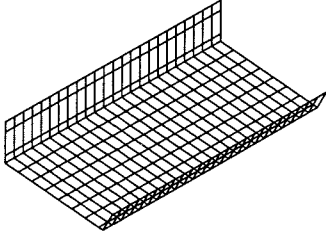
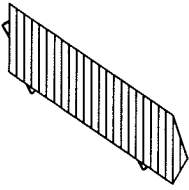
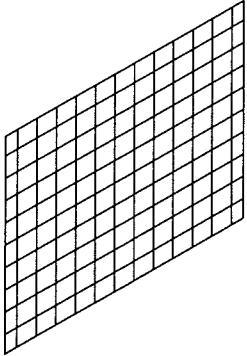
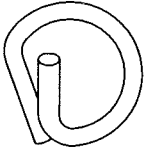
ACCESSORIES	DIMENSION	PART NUMBER	DRAWING NUMBER
<p>W.W. CONTINUOUS BINNING (MK2) CHROME (GRID 50mm x 75mm)</p> 	<p>HEIGHT FRONT 50mm BACK 150mm</p> <p>LENGTHS 600mm , 800mm , 900mm , 1200mm</p> <p>DEPTHS 450mm , 600mm</p>	<p>PART NUMBER SERIES 387230 - 387410</p>	<p>DWG # REFER PART#</p>
<p>W.W. CONTINUOUS BINNING DIVIDER (MK2) CHROME (GRID 20mm)</p> 	<p>HEIGHT FRONT 50mm BACK 100mm</p> <p>DEPTHS 450mm , 600mm</p>	<p>PART NUMBER SERIES 386450 - 386720</p>	<p>DWG # REFER PART#</p>
<p>HANGING MESH PANELS CHROME (GRID 75mm x 75mm)</p> 	<p>HEIGHTS 500mm , 900mm , 950mm 975mm , 1000mm 1200mm , 1225mm</p> <p>WIDTHS 625mm , 925mm 1225mm , 1525mm 1825mm</p>	<p>PART NUMBER SERIES 387560 - 387860 V37100 - V37167</p>	<p>DWG # REFER PART#</p>
<p>MESH PANEL PIGTAIL HOOK CHROME</p> 		<p>387880</p>	

LONGSPAN

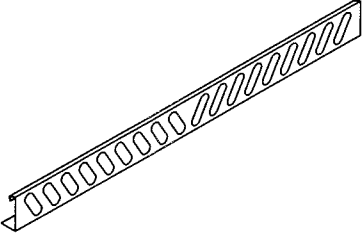
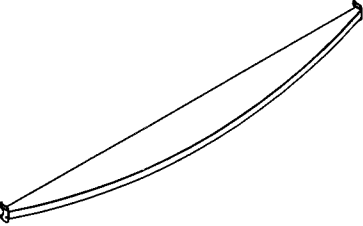
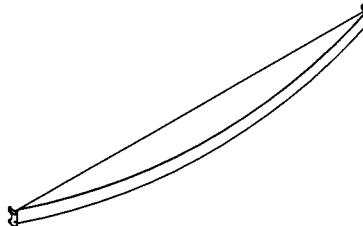
ACCESSORIES	DIMENSION	PART NUMBER	DRAWING NUMBER
<p>PUNCHED BIN FRONT</p> 	<p>890mm x 50mm 1780mm x 50mm</p>	<p>V36400 V36450</p>	<p>DWG # 34/074A DWG # 34/075A</p>
<p>LSPN CURVED SHELF EXTN</p> 	<p>1.8m</p>	<p>V36100 , 2</p>	<p>DWG # 34/053A</p>
<p>LSPN CURVED SHELF EXTN UTF 30mm</p> 	<p>1.8m x 30mm</p>	<p>V36150 , 2</p>	<p>DWG # 34/054A</p>

WW WELDED FRAME

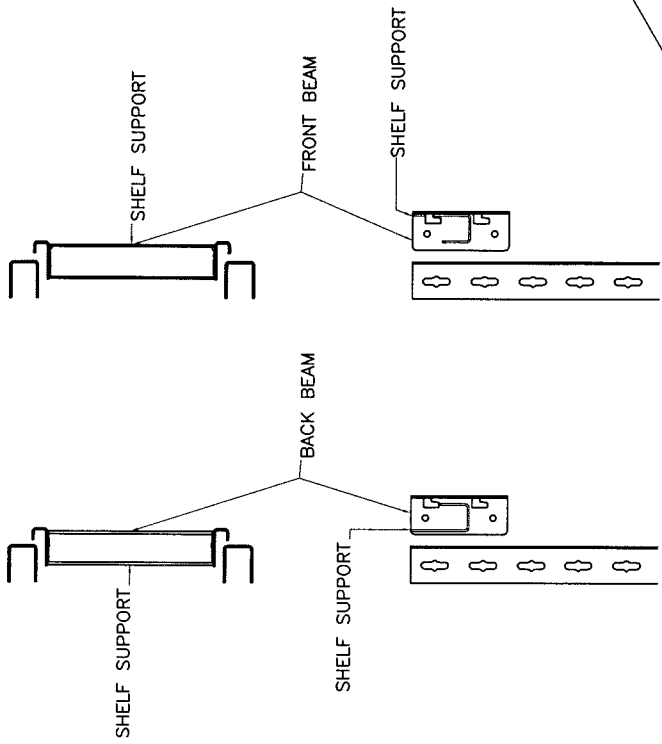

STANDARD WELDED FRAME

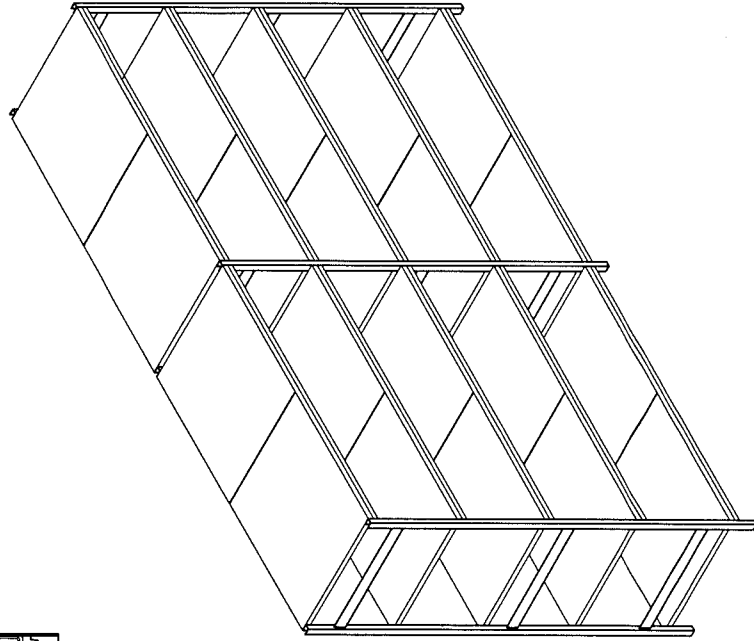
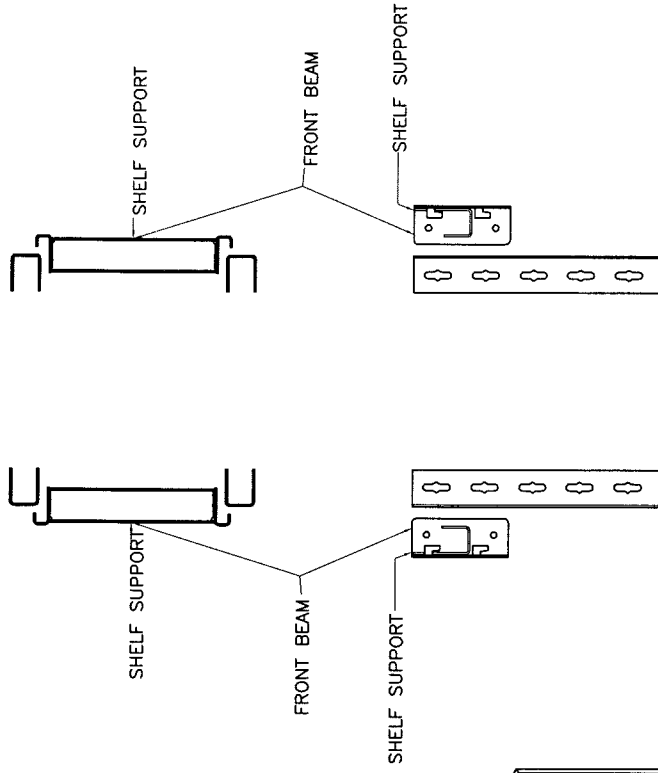

LS09

HYDESTOR MANUFACTURING LTD

MANUFACTURERS AND SUPPLIERS OF STEEL SHELVING SYSTEMS
AUCKLAND WELLINGTON CHRISTCHURCH

DRAWN
W.H.

ORIGINAL
A3

CHECKED

DATE
7/5/04

SCALE
1 : 25

SHEET
1

SERIES OF
1

SUPERSEDES

SUPERSEDED BY

REFERENCE No
LS09

PROPOSAL FOR: LONGSPAN

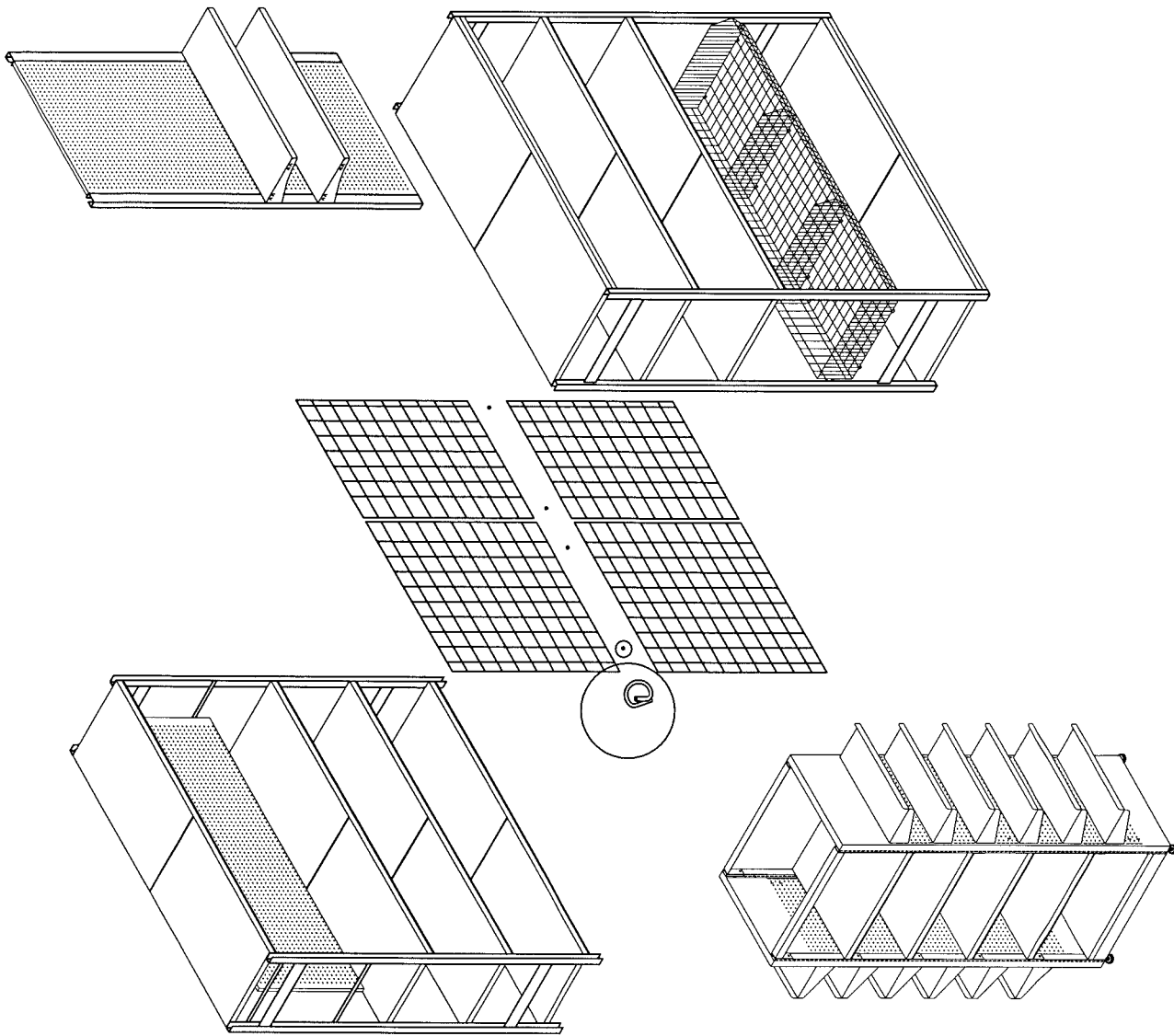

LS10

PROPOSAL FOR: LONGSPAN RETAIL

HYDESTOR MANUFACTURING LTD

MANUFACTURERS AND SUPPLIERS OF STEEL SHELVING SYSTEMS
AUCKLAND WELLINGTON CHRISTCHURCH

DRAWN
W.H.

ORIGINAL
A3

CHECKED

DATE
7/5/04

SCALE
1 : 25

SHEET
1

SERIES OF
1

SUPERSEDES

SUPERSEDED BY

REFERENCE No
LS10

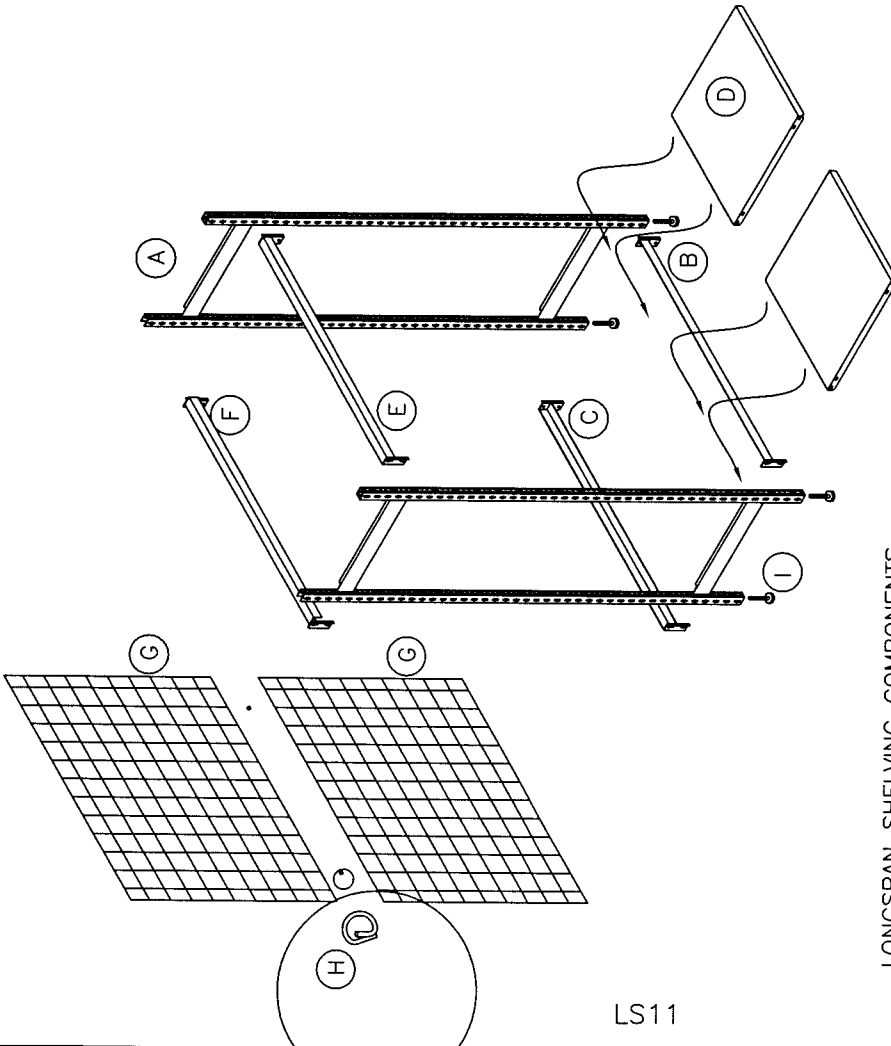

- LONGSPAN SHELVING COMPONENTS
- A) W.W. WELDED FRAME 2100x600 (450mm)
 - B) FRONT BEAM (1200mm)
 - C) BACK BEAM (1200mm)
 - D) SHELF 600mm x 600 (450mm)
 - E) BEAM FACIA 1200mm
 - F) HANGING CHANNEL BEAM
 - G) MESH BACK PANEL
 - H) MESH BACK PANEL PIGTAIL HOOK
 - I) ADJUSTABLE SCREW FOOT

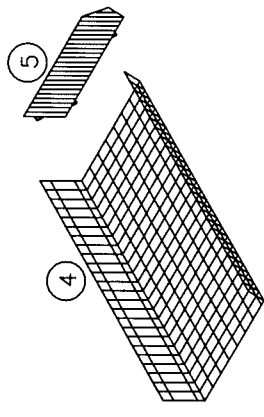
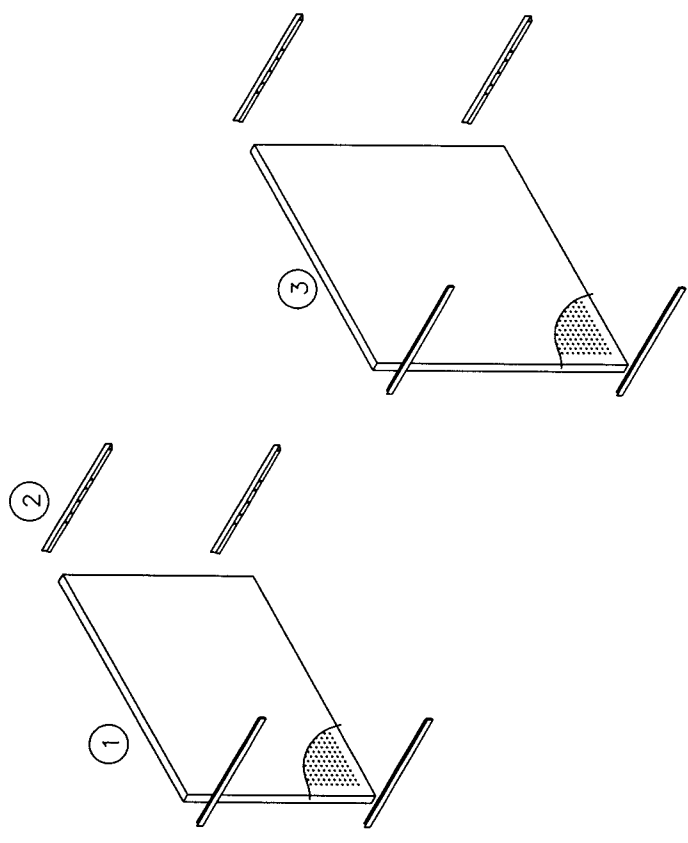

- LONGSPAN ACCESSORIES
- 1) PERFORATED LONGSPAN DISPLAY FRAME (900mm x 1200mm)
 - 2) PEG BOARD FRAME RAIL 600mm
 - 3) PERFORATED LONGSPAN DISPLAY FRAME (1200mm x 1200mm)
 - 4) CONTINUOUS BINNING (1200mm x 600mm) (CHROME FINISH)
 - 5) CONTINUOUS BINNING DIVIDER (600mm) (CHROME FINISH)

LS11

PROPOSAL FOR: STANDARD GROCERY SHELVING 1200mm MODULE
 - SHELVING COMPONENTS

HYDESTOR MANUFACTURING LTD

MANUFACTURERS AND SUPPLIERS OF STEEL SHELVING SYSTEMS
 CHRISTCHURCH
 WELLINGTON

DRAWN **W.H.**
 ORIGINAL **A3**

CHECKED

DATE 7/5/04

SCALE 1 : 25

SHEET 1

SERIES OF 1

SUPERSEDES

SUPERSEDED BY

REFERENCE No
 LS11

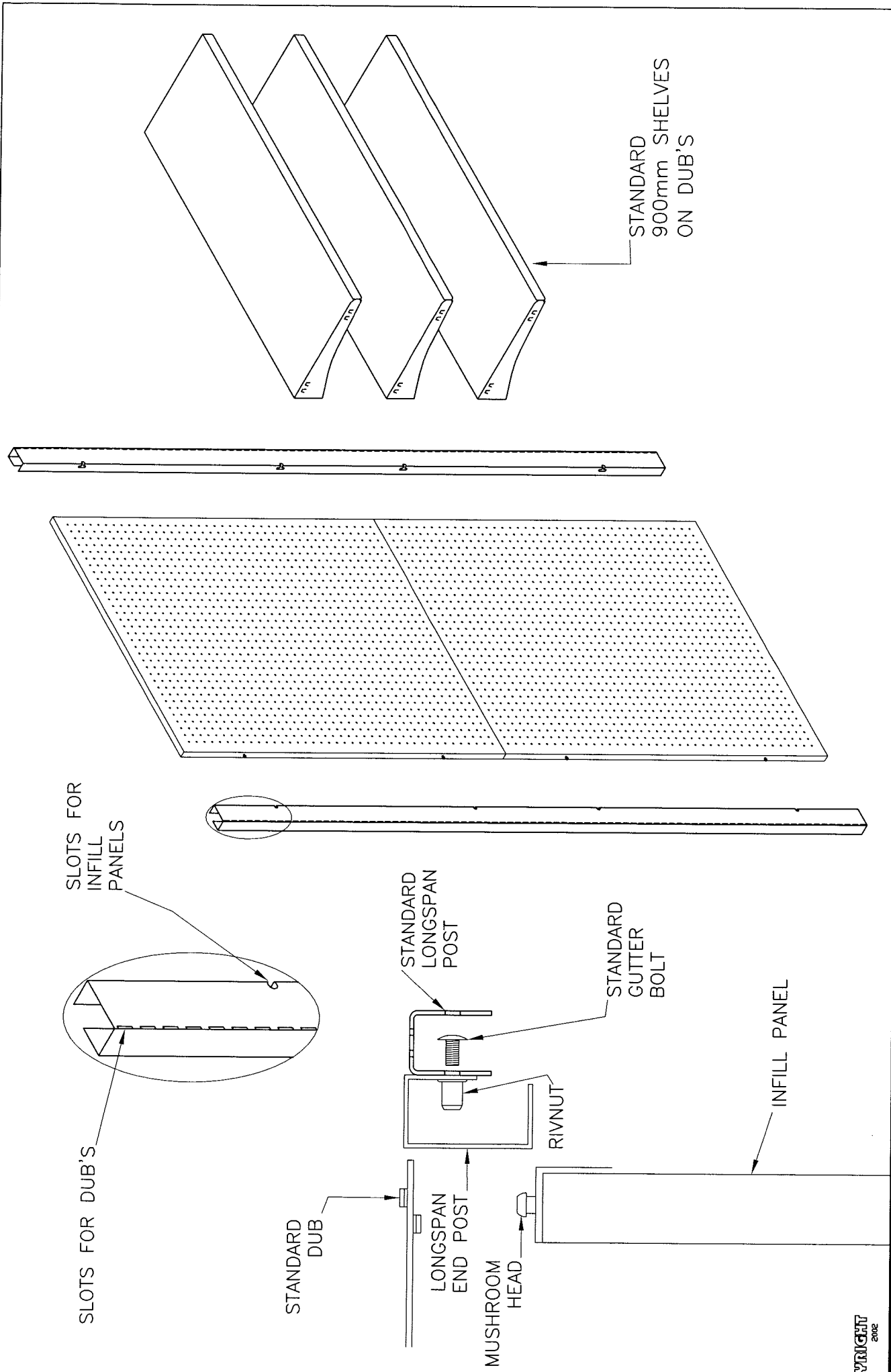

PROPOSAL FOR: LONGSPAN END POST – WITH INFILL PANELS

© COPYRIGHT 2002

HYPESTOR MANUFACTURING LTD

MANUFACTURERS AND SUPPLIERS OF STEEL SHELVING SYSTEMS
AUCKLAND CHRISTCHURCH WELLINGTON

DRAWN	CHECKED	DATE	SHEET	SERIES OF	SUPERSEDES	SUPERSEDED BY	REFERENCE No
MARCUS		7/5/04	1	1			LS12
ORIGINAL		N.T.S.					

LS12

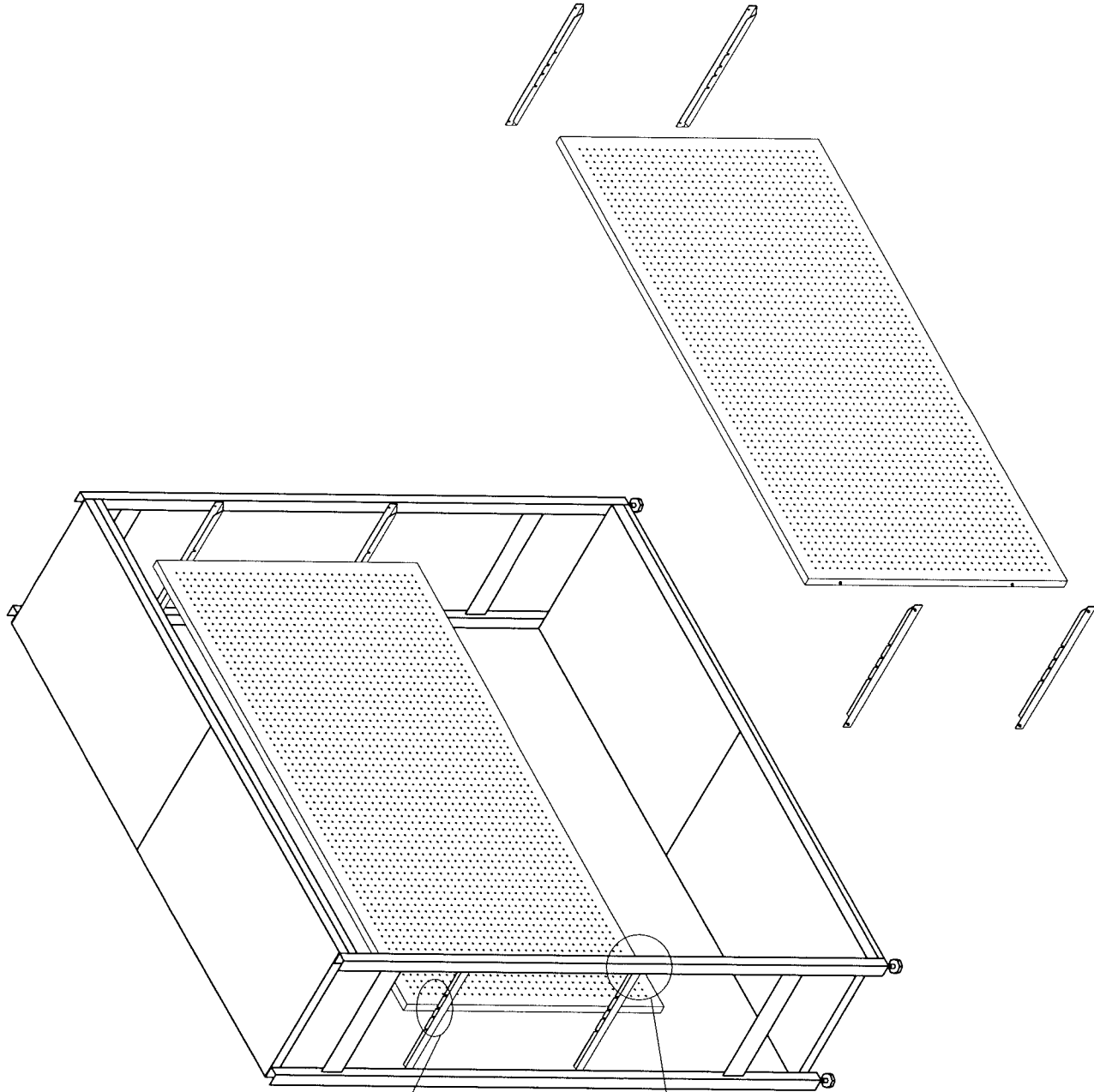

LS13

© COPYRIGHT
2002

HYDESTOR MANUFACTURING LTD

MANUFACTURERS AND SUPPLIERS OF STEEL SHELVING SYSTEMS
AUCKLAND WELLINGTON CHRISTCHURCH

PROPOSAL FOR: PERFORATED LONGSPAN DISPLAY FRAME ON PEGBOARD FRAME RAILS

DRAWN MARCUS	ORIGINAL	CHECKED	DATE 11/2/05	SCALE N.T.S.	SHEET 1	SERIES OF 1	SUPERSEDES	SUPERSEDED BY	REFERENCE No LS13
-----------------	----------	---------	-----------------	-----------------	------------	----------------	------------	---------------	----------------------

LSPN MOBILE BASE
MANUAL/MECH ASSIST

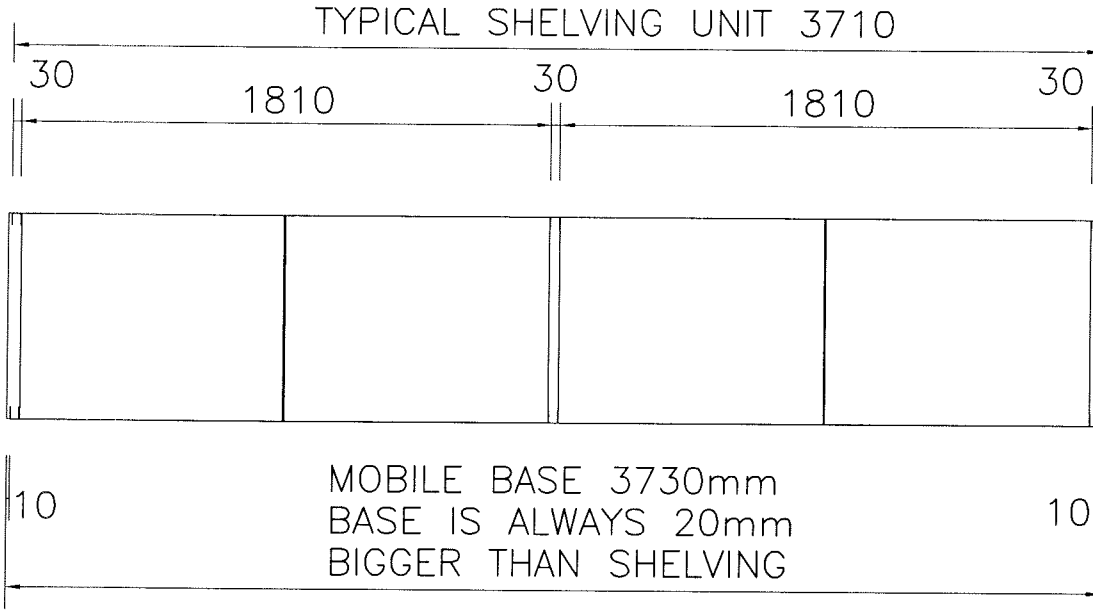

LSPN MOBILE BASE
WITH LSPN PERF/PLAIN ENDS

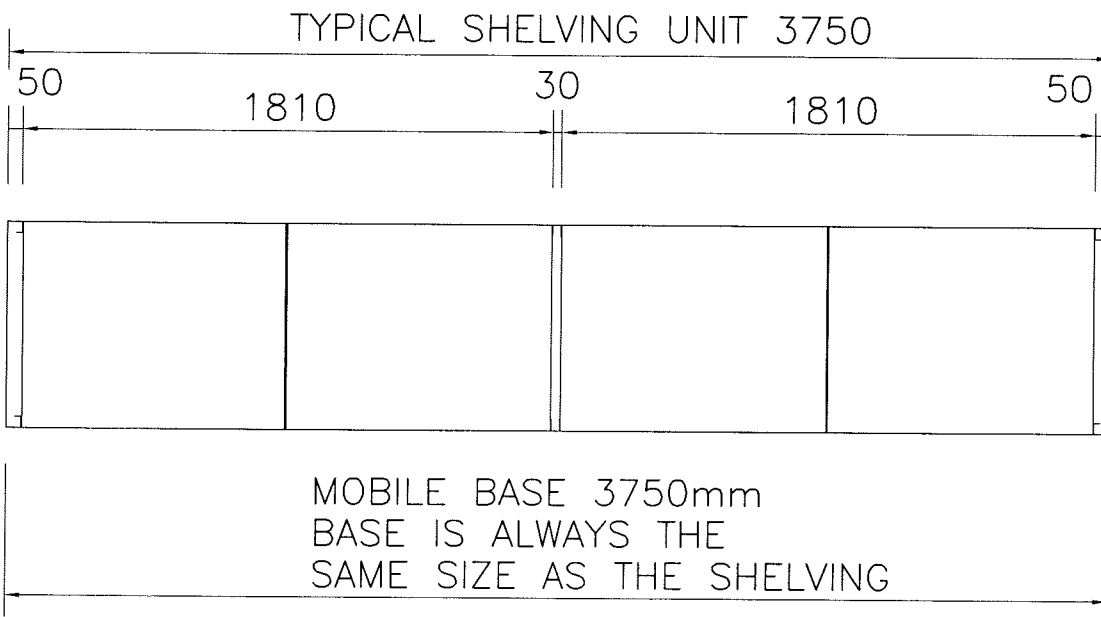

MANUFACTURERS AND SUPPLIERS OF STEEL SHELVING SYSTEMS AUCKLAND	CHRISTCHURCH WELLINGTON	DRAWN MARCUS	ORIGINAL	CHECKED	DATE 18/2/05	SCALE N.T.S.	SHEET 1	SERIES OF 1	SUPERSEDES	SUPERSEDED BY	REFERENCE No LS14
-------------------------------------------------------------------	----------------------------	-----------------	----------	---------	-----------------	-----------------	------------	----------------	------------	---------------	----------------------