

# HYDESTOR<sup>®</sup> SHELVING

*New Zealand's Shelving & Storage Solutions Leader*



## Library Collections

*Libraries are no longer just a place for books; they are challenged to be a multipurpose space that encourages creativity and learning, while seamlessly blending a mix of conventional and digital.*

*Often at the heart of a community, libraries offer a safe accessible space for people to interact with each other and share information and knowledge.*



## Hydestor Shelving Limited

Hydestor offers comprehensive and versatile library shelving design solutions utilising an extensive array of shelf types and accessories backed by an experienced sales and design team.

Our portfolio of customers includes representation from Primary Schools, Secondary Schools, Tertiary Institutions and Corporate Library Environments, both in New Zealand and overseas.

### What we do:

- We serve the New Zealand market with a complete offering of creative and trend setting shelving solutions.
- We design and manufacture steel shelving for many public, academic, corporate and specialist library environments.
- We keep abreast of the changing and challenging scenarios facing the 21st century library.
- We strive to make libraries a focal, more attractive and successful experience for communities and individuals.
- We work with library staff, architects, designers and other professionals to develop functional library environments.
- We adapt our services to suit your needs, budgets and time lines, while delivering inspirational spaces.

### What we offer:

- An experienced team of people committed to excellence in shelving.
- The ability to deal directly with the manufacturer which provides an assurance of quality, competitive pricing, excellent service and design flexibility.
- Full consultancy service free of charge, provided by trained consultants.
- Choice of a large number of standard sizes, or customised products made to order.
- Specialised design solutions tailored to meet your requirements.
- A written PS3 Producer Statement issued for every installation as assurance of a quality installation.
- Extensive range of powder coat colour finishes.
- Installations guided by "NZS4101" 1994 Guidelines for seismic restraint of building contents.

## Purpose Built for New Zealand

At Hydestor, we assess each project based on its specific circumstances. When designing a shelving installation, we focus on maximising the overall structural integrity and user safety. While our mobile rollaway shelving units are largely unaffected by seismic events, static units are more vulnerable and may require support by fixing to floors, walls or have overhead tie arrangements depending on their height and depth. All of this is taken into account while designing your library environment.

## Our Environmental Commitment

Hydestor Shelving Ltd are committed to a company wide Environmental Sustainability Policy to prevent or mitigate harmful effects on nature and natural resources during the life cycle of our products and processes.

This commitment is delivered by a variety of company initiatives under four main criteria:

1. Efficient use of energy
2. Use of recyclable raw materials
3. Divert from landfill
4. End of Life / Product Stewardship

We are proud to have been accredited by Environmental Choice New Zealand, reflecting our commitment.



## 100% Kiwi Owned - 100% Quality Focused

Hydestor have been designing, manufacturing and installing shelving and storage systems since 1989. In all that time, we've had a 100% focus on delivering our customers quality products and working solutions. Solutions that fit the specific needs of each of our clients.

Today, we have joined forces with a state of the art manufacturing plant. While the way we produce our products has changed dramatically, our promise to our customers has not. We still deliver the same great products matched to the specific needs of our clients – which has helped us to become the supplier of choice for some of New Zealand's leading businesses, schools, councils and museums.

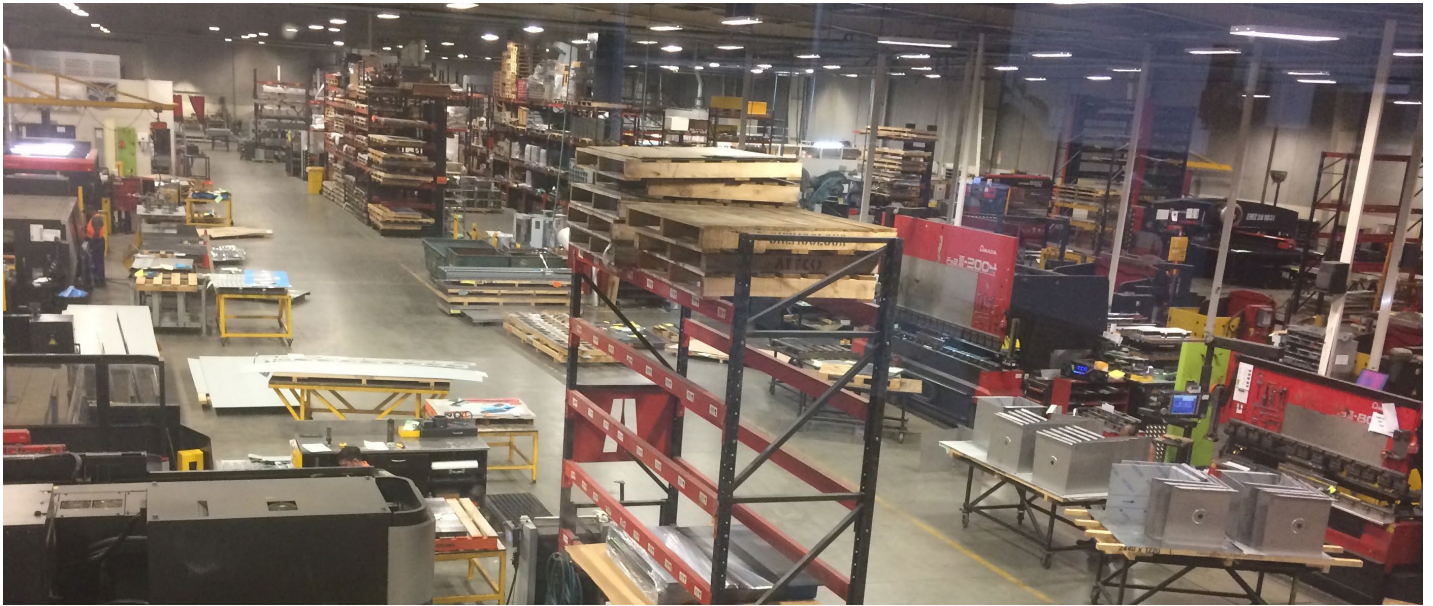

## A Little Background

Hydestor Shelving Ltd is a privately owned New Zealand company whose team has over 50 years combined industry experience.

Our Head Office is based in East Tamaki, Auckland with our South Island Office in Christchurch. Employing more than 25 staff, we specialise exclusively in the development, supply and installation of adjustable, powder coated steel shelving systems and their appropriate accessories, utilising our in-house CAD systems. The major components in manufacture are steel and powder (finishing) which are purchased locally. Freight and labour costs contribute to the local economy and typically 95% of the componentry is New Zealand made.

Hydestor Shelving Ltd's production is managed by our sister company, Metal Skills, whose modern plant boasts state of the art computer controlled manufacturing processes and the finishing is completed through their own semi-automated powder coating line. The company has an ongoing commitment to service and quality.

Metal Skills has been in business for over 25 years and has an enviable reputation for quality and service. Metal Skills invests heavily in ensuring that their manufacturing equipment and their team are at the forefront of sheet metal manufacturing technology with an ongoing significant investment in both equipment and training.

Our client base is extensive and includes many of the country's most prestigious company groups, together with major government departments and associated entities for which we have designed and installed many significant projects. The company has been exporting throughout Australasia and Asia for the past 20 years, regularly completing major off-shore installations and has gained an enviable reputation across a range of markets.

# Tūranga Christchurch Central Library



At nearly 10,000m<sup>2</sup> Tūranga is the most modern public library in the Southern Hemisphere and the largest in the South Island.

Working with the Christchurch City Council, Architectus, South Base Construction, OCTA and JB Joinery, Hydestor was proud to be an integral part of this project.

Hydestor provided over 95% of the shelving requirements which totaled over 5.5 kilometres of steel shelving and holds more than 180,000 books both on public display and archived.

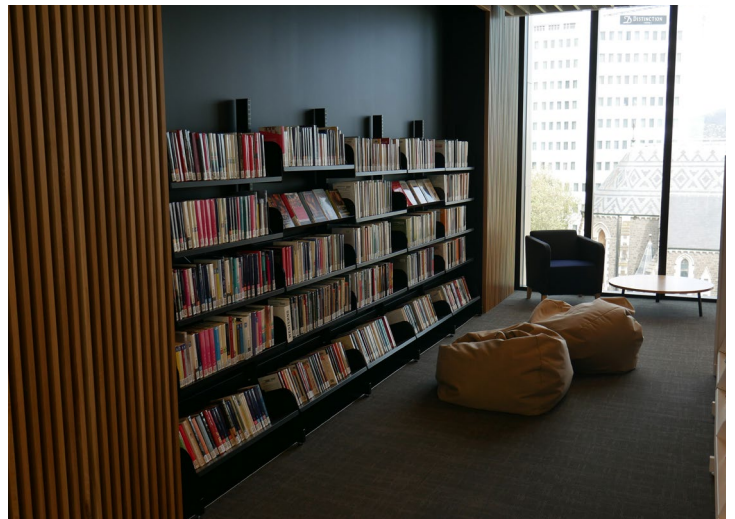

## St Andrew's College Library

St Andrew's College is a private school in Christchurch which caters for students from preschool to senior college.

Hydestor have been a key supplier of shelving solutions throughout the school for many years, together building a close working relationship.

We were very happy to be part of their senior college library/technology building refurbishment, working in conjunction with the architect to create a timeless contemporary space.

This project incorporates one of our new products, 'Autex' Library End Panels. A pinnable surface with acoustic qualities for noise reverberation reduction, often appreciated in such open spaces.



## Devonport Library

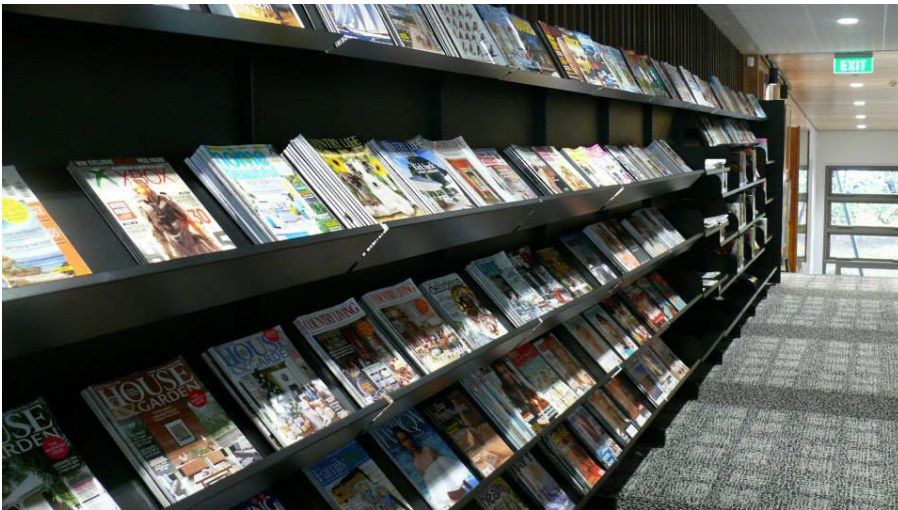

Often referred to as "A beautiful Boutique Library located on the Village Green by the Sea"

Designed by Athfield Architects and constructed by Naylor Love, this library features high ceilings, a mezzanine floor and an extensive array of significant art pieces.

Housing around 41,000 titles on Hydestor's static and rollaway shelving within a space of 950m<sup>2</sup>, Devonport Library is one of Auckland Council's 55 libraries.

This Hydestor shelving project was a delight for our experienced team to work on and consisted of a mix of black Meltica Slatwall library end panels and Mannex Matt Black powder coated steel shelving.

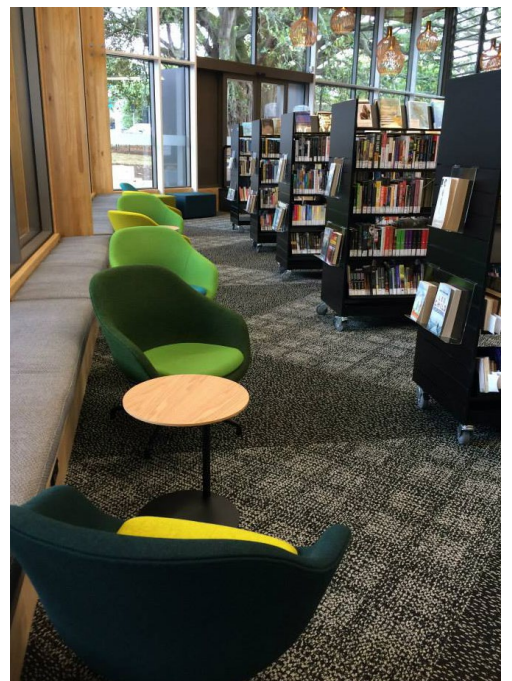

# St Cuthbert's College Library

Over time, the senior college library space has evolved to also become the global commons hub as well as an event and function space, which necessitated the requirement for the library collection to become readily movable.

Hydestor Shelving have provided a highly functional, aesthetically pleasing "Rollaway" library shelving layout that has enhanced the display and accessibility of the collection.



# Hydestor Componentry

Hydestor offer a vast array of Library Componentry, as demonstrated on the following pages.





## Post and Frame Options



### Freestanding Single Faced Post

Standard Height: starts at 775mm and goes up in 100mm increments to 2375mm.

The foot options are 250mm and 300mm deep.

The shelving can be adjusted in 25mm increments.



### Freestanding Double Faced Post

Standard Height: starts at 775mm and goes up in 100mm increments to 2375mm.

The foot options are 250mm and 300mm deep.

The shelving can be adjusted in 25mm increments.



### Rollaway Shelving Units

There are different height units to suit all requirements.

A heavy duty 100mm wheel is used to support the weight.



### Wall Mounted Channel

Comes in standard lengths of 1150, 1500, 1800 and 2300mm.

This system requires a structurally stable wall.

### Standard Bay widths: 600mm and 900mm

- Our freestanding units are supported with back braces and seismic bracing every second bay.
- Stability fixings are usually installed directly to the floor or wall behind the library shelving.
- Hydestor shelving systems are engineered for stability, strength and rugged functionality.
- Our sturdy heavy-gauge steel welded frame construction meets and exceeds all standard for structural integrity.

# Shelving Options



## Flat Shelves

Available in 200, 225, 250, 300, 350 and 375mm standard depths.  
Can be used with overslung or underslung brackets.



## Display Shelves

Available in various depths with either a 25mm or 60mm deep front lip. Most commonly used with our 15-60° brackets.



## Uptilt Bin

Depths available 200mm and 250mm.  
Used for displaying larger books face out.  
Available with or without dividers.



## Low Profile Browser Bin

Depths available 200mm, 250mm and 300mm.  
Used for displaying smaller books and DVD's face out.  
Available with or without dividers.  
Flat or uptilt bracket options available.

### Did you know?

- Hydestor is 100% New Zealand owned and operated.
- We source 99.6% of our raw materials from within New Zealand which fully supports our local economy.
- Our flexible system allows for a variety of tailored solutions which our sales and design team brings to life for each individual library.

# Shelving Options



## Uptilt Base Shelf

Depths available 150mm, 200mm, 250mm and 300mm.  
Various bracket configurations allow a shallow shelf to sit forward from the vertical post so users can locate a title without the need to bend down.  
Flat or uptilt bracket options available.



## Welded Uptilt Shelf

Depths available 200mm and 250mm.  
Very similar to the Uptilt Base Shelf but these shelves are a one piece bracket and shelf combo.



## Magazine Serial Shelves

This shelf is like a display shelf except it has a large 100mm lipped front, typically used on our heavy duty 45° or 60° angled brackets to store back issues.



## Slotted Divider Shelf

Available in 250mm and 300mm depths.  
Easily adjustable dividers at 35mm increments (optional).  
Ideal for breaking up small collections on one 900mm wide shelf.

We make your space work!

**Functional, Fun and Operational**

# Shelving Options



## Clearview Shelf

A space saving yet effective medium for displaying journals or single issues of magazines.

Acrylic dividers are set at a 45° angle that allows individual viewing. Each aperture can be positioned in increments of 25mm, with up to 18 divisions per shelf.



## Magazine Tier Shelves

Available in 2 or 3 tier configurations.

Designed to neatly display commonly used items such as picture books, magazines, serials, brochures etc.

Features display trays (900mm long x 250mm high x 40mm deep). Also available with a base tray that is 70mm deep.

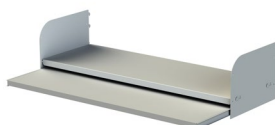

## Reference Shelf

This slide out shelf positioned below a conventional flat shelf, is designed to be used as a handy working surface within a shelving run.



## AV DVD/CD Shelf

For displaying DVD's / CD's face out or spine out.

A combination of both can be achieved.

A special feature of this shelf is a central 'indented groove' running the length of the shelf which allows light weight items to be faced out without slipping off the shelf.

Since 1989, we have been pioneering libraries of all kinds throughout New Zealand and Australia. Today, we deliver our experience, expertise and creativity with a flexible system of high-quality new Zealand made products. The result is innovative library designs.

# Shelving Options



## **AV Shelf**

Dividers available, allowing for internal separation if required.



## **AV Shelf 2 Tier**

Dividers available, allowing for internal separation if required.



## **AV Shelf 3 Tier**

Dividers available, allowing for internal separation if required.

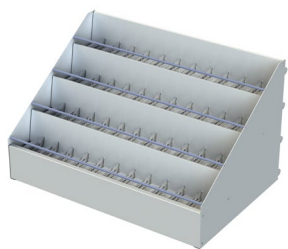

## **AV Shelf 4 Tier**

Dividers available, allowing for internal separation if required.

Extensive powdercoat colour range available

## Shelving Options



### Canopy Shelf Single Faced

Comes complete with either a 35mm or 70mm back spacer that fills the cavity between the shelf and the upright post.



### Bridge Canopy Shelf Double Faced - Single Bay

An attractive 'One Piece' top shelf designed to fit the top of double sided free-standing or rollaway units.

Seamlessly interlocking into library end panels to create an encasement bookcase design.



### Bridge Canopy Shelf Double Faced - Double Bay

An attractive 'One Piece' top shelf designed to fit the top of double sided free-standing or rollaway units.

Seamlessly interlocking into library end panels to create an encasement bookcase design.

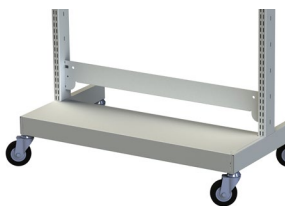

### Rollaway Base Shelf

Completes the 'look' by hiding structural bracing.

Our experienced team help you create your dream library from concept to completion!

#### We are here to help:

- 2D and 3D Cad drawings, custom design and development
- Free advice and consultation
- Full installation service available

# Library End Panel Options



**Standard End Panel**  
Square edge c/w slots



**R20 Curved Edge Plain End Panel**



**R20 Curved Edge Plain End Panel c/w side slots**



**R20 Curved Edge Plain Slat End Panel**

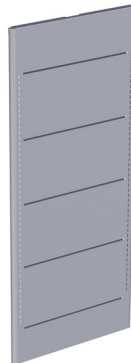

**R20 Curved Edge Plain Slat End Panel c/w side slots**



**Cube End Panel**



**Melamine Slat Wall End Panel**

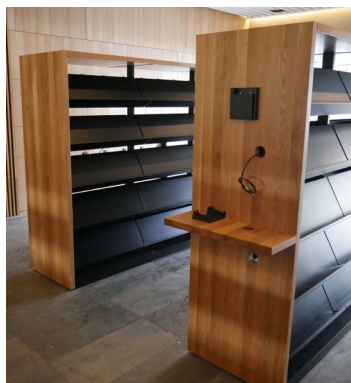

**Bespoke Timber End Panels**

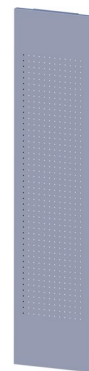

**R20 Plain Single Faced End Panel**

Your design options are virtually unlimited. Hydestor library shelving is available in an imaginative range of colours along with an array of end panel materials and finishes to match and complement any décor.

By simply adding a canopy shelf you create the illusion of a framed bookcase styled unit.....thus giving the shelving system minimalist design expression.

## OPAC Options (Online Public Access Catalogue)



### Fixed Height OPAC on End Panel

Available in either standing or sitting height configurations.  
Optional keyboard tray.



### OPAC on End Panel - Adjustable

Adjustable height OPAC on end panel.



### OPAC Wall Mounted



### OPAC Pedestal

Versatile pedestal units with the ability to fit monitor screens and keyboards to both sides.  
Cable access via top and base of towers.

- Our broad range of components in the Hydestor Library shelving system creates endless possibilities when designing your library.
- Single faced, double faced, wall mounted, rollaway, end panels in different materials, shelves for different purposes, accessories and so much more.
- We make it all right here in New Zealand and have a large sales team throughout the country ready to assist with all your shelving and storage requirements.



## Library Book Return Trolleys



### Workstation Trolley

Height	1100mm
External Width	550mm
Internal Shelf Width	500mm
Depth	300mm



### Flat Shelf Trolley

Height	1100mm
External Width	850mm
Internal Shelf Width	800mm
Depth	500mm



### Sloping Shelf Trolley

Height	1100mm
External Width	850mm
Internal Width	800mm
Depth	500mm
Dual sided (each side)	200mm

Standard colour as shown is Mannex Matt Black, other colours available upon request

Don't compromise on choice or quality.....Choose Hydestor shelving for your next project!

As the backbone of the library, shelving should be practical and reliable, yet offer flexibility for future needs. With Hydestor you're assured of the very best quality product along with the latest in functionality and design.

## Additional Items



### Royal Book End

An attractive yet functional top of the range product. Designed with anti-slip grommets and a stylish perforated up stand. Two sizes available 170mm and 220mm high.



### Library Index Block

Steel indicator block available in a range of colours to match your décor. Standard sizes 190mm high x 110mm deep in either 60mm or 90mm wide. Lettering not supplied.

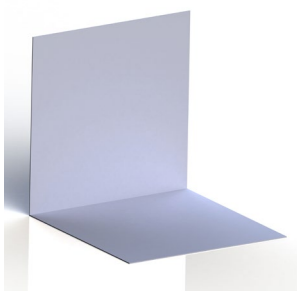

### Book Support

Standard 'L' shaped book end, made with steel and finished in durable powdercoat.

Four sizes available:

- 177mm x 119mm x 135mm
- 202mm x 144mm x 135mm
- 227mm x 169mm x 135mm
- 230mm x 230mm x 230mm

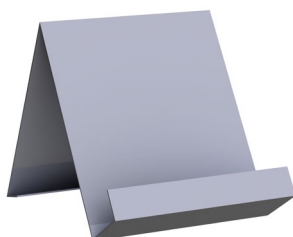

### Book Display Stand

Sturdy book display stands are a great way to showcase books.

Proudly NZ Made



## Additional Items



### Library Shelf Bin

Allows for face out book display within spine out books.  
Available in 200mm and 250mm deep.



### Audio Visual Bag Rail

Constructed as an 'S' section, this rail is designed to hang pre-bagged audio and visual items.  
Designed to accommodate either large or small mounting hooks.

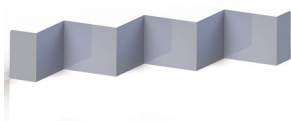

### Zig-Zag Supports



### Rollaway Tow Bar

### Are you not seeing what you are after?

Please contact us directly as we have experienced sale and design consultants ready to help with all enquiries no matter how simple or complex.  
Simply call us on 0800 493 378 or email [info@hydestor.co.nz](mailto:info@hydestor.co.nz).

# Hydestor's Exclusive Range



1. Canopy Shelf
2. 15-60° Display Shelf
3. Slopping Shelf 60mm Front
4. Slopping Shelf 45° 60mm Front
5. Slopping Shelf 100mm Front
6. Library Index Block
7. Library Book Bin
8. Pull Out Reference Shelf
9. Library Book Bin (non-fiction)
10. Base Uptilt Shelf
11. Flat Browser Bin (dividers available)
12. Uptilt Browser Bin (dividers available)
13. Book Tub
14. Uptilt Display Bin

15. Flat Shelf
16. Zigzag Stand
17. Slotted Shelf Divider Set
18. Periodical Shelf Set
19. Paperback Shelf
20. Hanging Bag Rail
21. Two Tier Display Unit
22. Three Tier Display Unit
23. DVD Presentation Shelf
24. AV Shelf
25. Two Tier AV Shelf
26. Three Tier AV Shelf



## Hydestor "Curve" Library Shelving

*a new story around every "bend"*



Introducing 'Curve', Hydestor's newly launched library product designed to provide critical functions in modern libraries. It is a unique library system that complements our classic straight shelving system and brings your library space to life... creating zones, nooks and pathways to diversify a simple interior design.



## Library Signage



Standard single and double sided sign holders available.



## Mobile Browser Bin



Mobile Joinery Browser Bins are available in 3 sizes and in a range of colours.

The options are endless - our flexible system allows for a variety of tailored solutions. Contact us today to find out more!

# Design Layout Examples

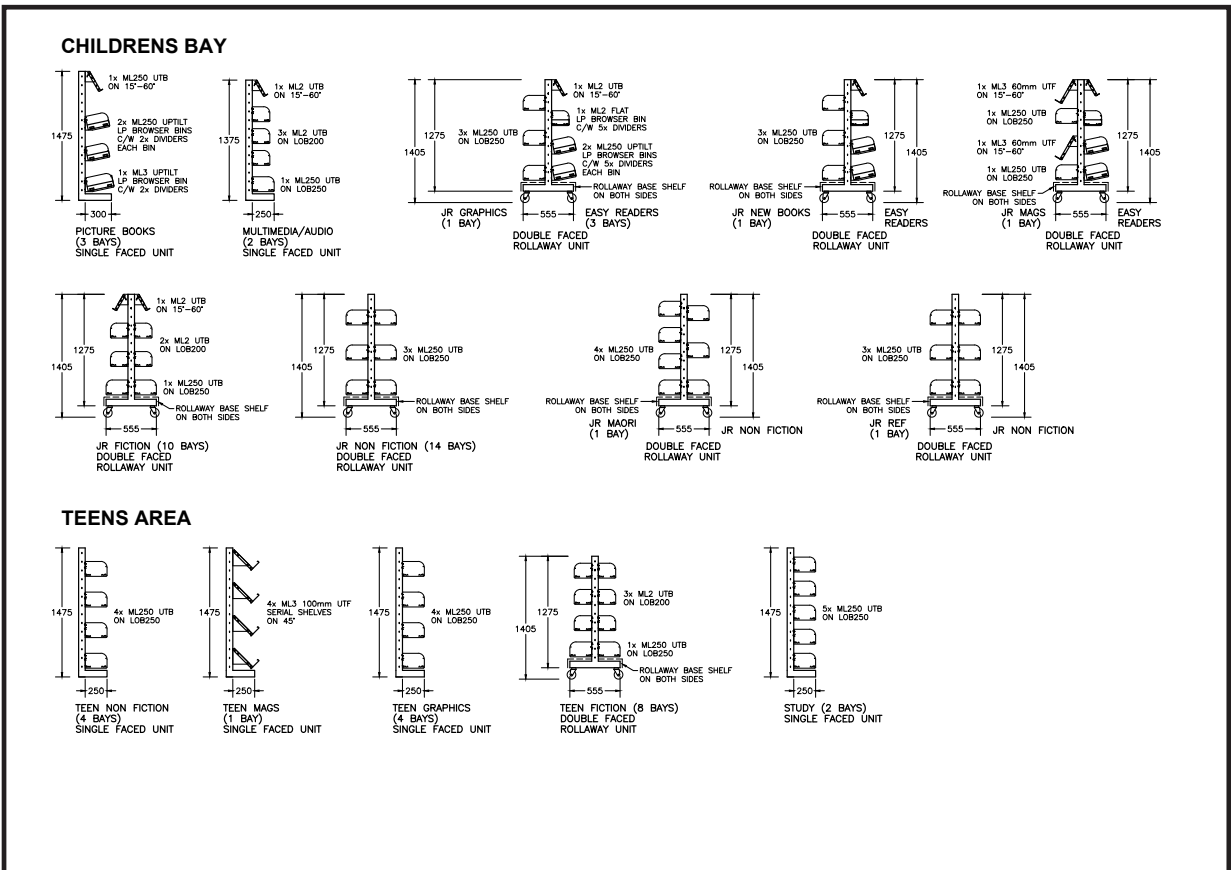
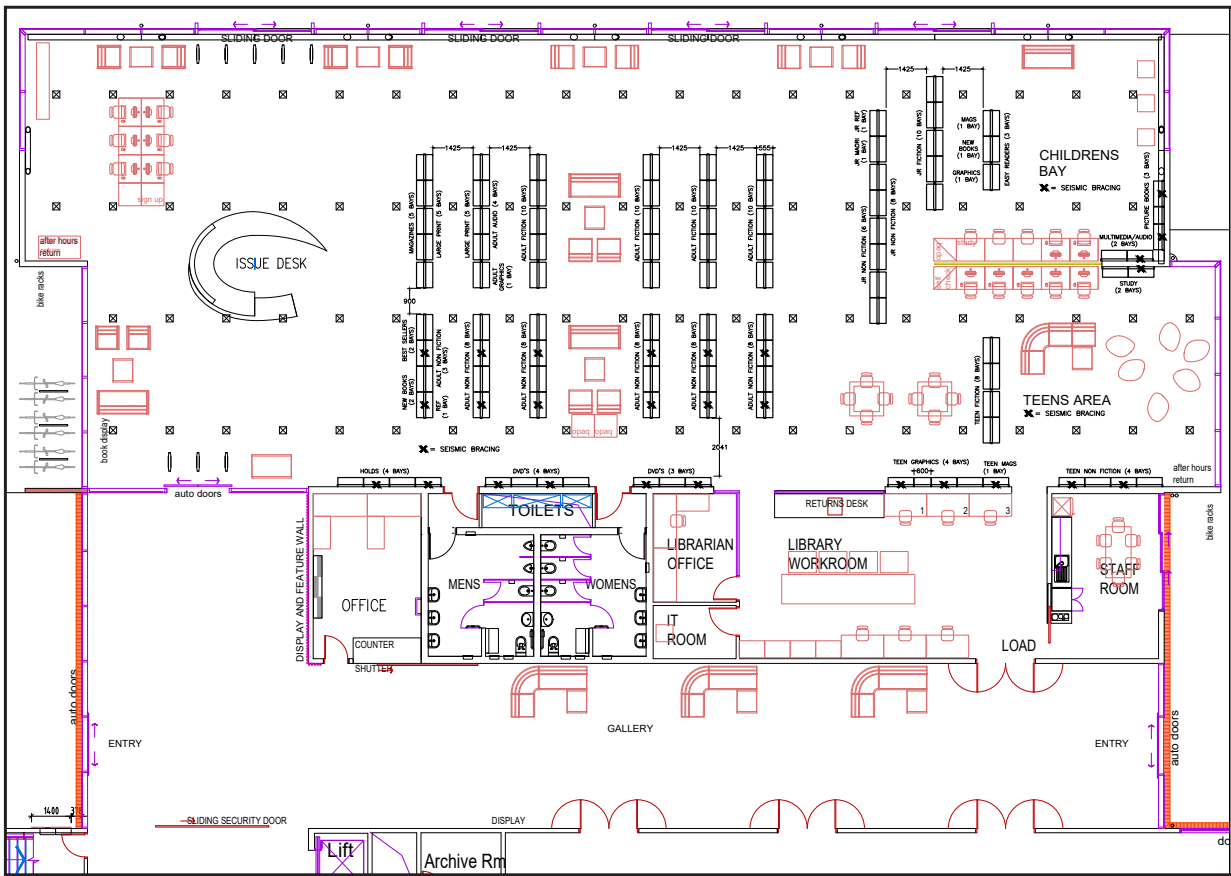



# Hydestor Shelving Inspirations



# Hydestor Shelving..... Not Just Library Shelving

Mobile Shelving



Longspan Shelving



Retail Shelving



Mobile Art Shelving



Shuttle Shelving



Post Shelving



Panel Shelving





# **HYDESTOR<sup>®</sup>** **SHELVING**

*New Zealand's Shelving & Storage Solutions Leader*



*Export +64 800 493 378*



*New Zealand - 0800 493 378*

*0800 493 378 - [info@hydestor.co.nz](mailto:info@hydestor.co.nz) - [www.hydestor.co.nz](http://www.hydestor.co.nz)*